



Technical comercial data

N-5.8 T.N-5.8

Serie NOVA – Versión 31-07-2024

TECHNICAL DATA:

Material:	PP copolymer of first quality, suitable for contact with food according to current regulations.
Colours:	White standard. Consult for other colours.
Useful Volume:	5.8 litres
Volume to the edge:	6.3 litres
Weight of the bucket:	202 g. approx.
Weight of the lid:	60 g. approx.
Weight of the handle (plastic):	8 g. approx.
Total Weight:	270 g. approx.
Decorative surface flat inks:	155 x 595 mm (height x perimeter)
Design surface photographic finish:	165 x 605 mm (height x perimeter)



MEASUREMENTS:

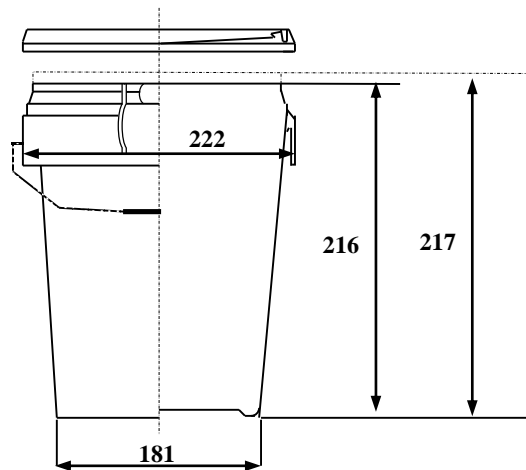

Measurements in millimetres

GROUPING OF TRANSPORT:

Buckets:	600 buckets per pallet
Pallet dimensions:	1180 x 950 x 1140 (see drawing)
Lids:	200 lids per box, this serves as a packaging of transportation
Box dimension:	483 x 244 x 815

